

Angular momentum conservation and the cat twist

John Ronald Galli

Citation: *The Physics Teacher* **33**, 404 (1995); doi: 10.1119/1.2344252

View online: <http://dx.doi.org/10.1119/1.2344252>

View Table of Contents: <http://scitation.aip.org/content/aapt/journal/tpt/33/6?ver=pdfcov>

Published by the [American Association of Physics Teachers](#)

Articles you may be interested in

[ANGULAR MOMENTUM CONSERVATION WITH A TWIST](#)

Phys. Teach. **47**, 6 (2009); 10.1119/1.3049869

[Demonstrating conservation of angular momentum](#)

Phys. Teach. **43**, 552 (2005); 10.1119/1.2120390

[Angular momentum conservation demonstration](#)

Phys. Teach. **27**, 561 (1989); 10.1119/1.2342870

[Demonstrating conservation of angular momentum](#)

Phys. Teach. **22**, 391 (1984); 10.1119/1.2341591

[The Conservation of Angular Momentum](#)

Am. J. Phys. **33**, 345 (1965); 10.1119/1.1971501



Angular Momentum Conservation and the Cat Twist

John Ronald Galli

Weber State University, Ogden, UT 84408-2501

A cat, falling from a few inches or more, seems to always be able to land on all its feet, even when suspended upside down and carefully dropped without external torque. The possible mechanism of this torque-free twist has been discussed by various investigators over a period of several years.¹⁻⁵ This paper deals with a mechanical model that is able to duplicate the twist of a real cat, and do it in a way that appears to require minimum time and coordination. A sampling of current physics textbooks⁶⁻⁸ suggests that the primary mechanism of the cat twist involves the cat rotating the two halves of its body in opposite directions with different relative speeds by varying the respective moments of inertia through leg extension and retraction. Another mechanism, involving the tail rotation, has also been reported⁹ and appears to be involved in certain situations. Although these procedures allow the cat to do a torque-free twist, there is evidence that these methods are only of secondary importance.

The idea to mechanically model the cat was triggered by a summary article in *Scientific American*⁴ on the physics of diving and other aerobatics, including the cat twist. In that article, the simplified cat is analyzed as being comprised of two halves that can either rotate in opposite directions with different speeds (referred to above), or rotate toward one another while systematically rotating in the “opposite” direction (to be described below). The first method, popularly presented, involves the cat twisting one half of its body in one direction while the other half twists more slowly in the opposite direction. Then the process is reversed, in a sense, so that the second half catches up to the first half as the cat completes the 180° twist to right itself. This method is totally

consistent with the principle of angular momentum conservation and appears to be a good partial explanation. However, the second method, described here, seems simpler and appears to me to be the primary mechanism involved.

The *Scientific American* article states that there is an open question as to whether in practice a cat *needs* to vary the relative moments of inertia of its upper and lower body. The mechanical cat I have devised does not require relative repositioning of the legs. Also, it does not require that the two halves twist in opposite directions. It does, however, require a bent spine. This mechanical cat is capable of completing the twist without a net torque and without any initial angular momentum.

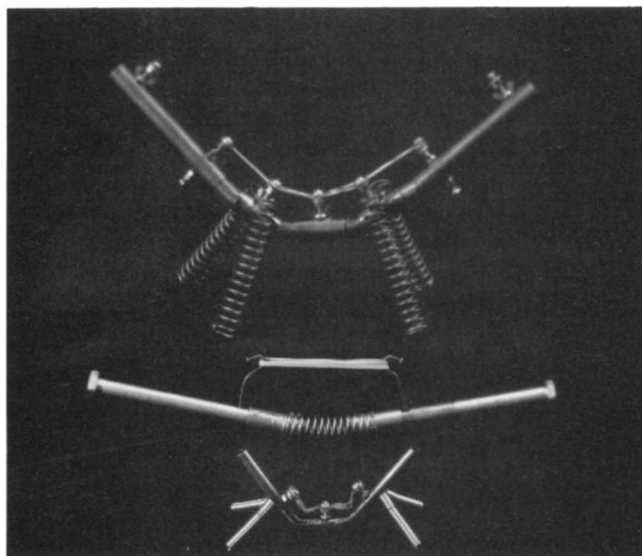

Fig. 1. Three versions of the mechanical cat.

The Mechanical Cat

Two versions of the multi-jointed mechanical cat with legs are shown in Fig. 1 (top and bottom). A single-jointed simplified version (in the center) shows the essence of the spinal mechanism. The ener-

gized mechanical spine is shown in Fig. 2. When the energized mechanical spine is allowed to slip through the holder's fingers, it suddenly flips over. This twisting motion, which is difficult to stop once it starts, is shown sequentially in Figs. 2-4. Note that a cat's spine is multijointed, and many joints are likely to be simultaneously or sequentially involved in a given twist maneuver, but the *number* of joints is not essential to this discussion. Also, the simplified mechanical model, when confined in the hands, does not demonstrate the total motion, but only that part of the motion essential to the turning over.

The mechanical cat apparatus consists of a taut cord (such as rubber band or bungee cord) tied to two adjacent parts, as shown in Fig. 5. The two parts are connected at the center by

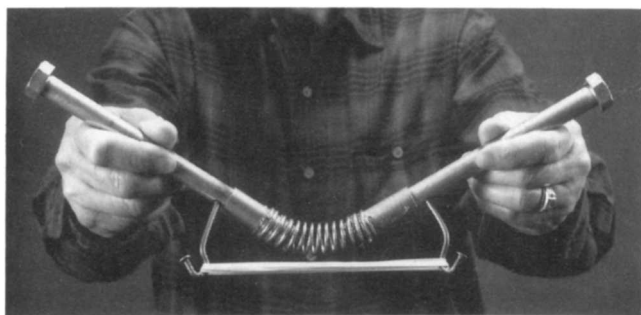

Fig. 2. Energized mechanical spine.

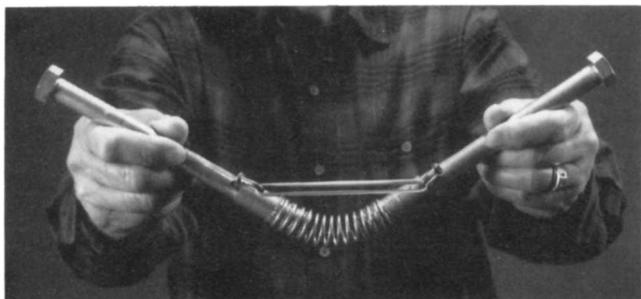

Fig. 3. Energized spine as it is turning over.

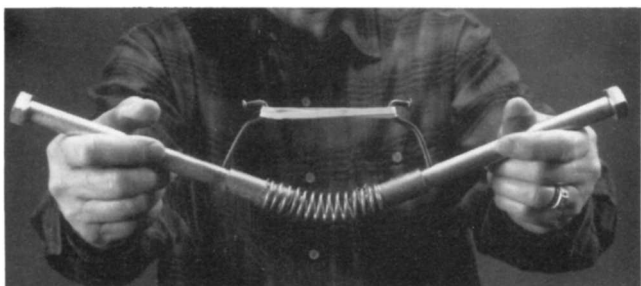

Fig. 4. Mechanical spine after turning over.

a spring that is capable of flexing, and which serves as a joint. The real cat is capable of tightening the muscles and stretching the ligaments, which are attached to the spine at the various projection points or processes. Figure 6 shows a photograph of the cat skeleton.

When the “spine” is bent and energized, as shown in Fig. 7, two adjacent parts, or halves, for simplicity, will pull together with action-reaction forces F_1 and F_2 (see Fig. 8, the force-and-motion diagram). Note that the forces F_{1A} and F_{2A} will supply torques on each half, respectively, which will cause the two halves to twist toward one another (motion 1 and motion 2). This will result in an angular momentum change $\Delta L_1 + \Delta L_2$, or simply $L_1 + L_2$ (since motion begins from rest). This must be balanced by the entire system rotating with motion 3, with an associated angular momentum change L_3 in the opposite direction, as shown in the diagram. Note that $L_1 + L_2 + L_3 = 0$, so that there is *no net change in the angular momentum* and the mechanical cat has turned 180° , from backside down to backside up without the application of a net torque. Motion 3 is due to the combination of F_{1B} and F_{2B} supplying a torque to twist the entire object about a horizontal axis passing through the center of

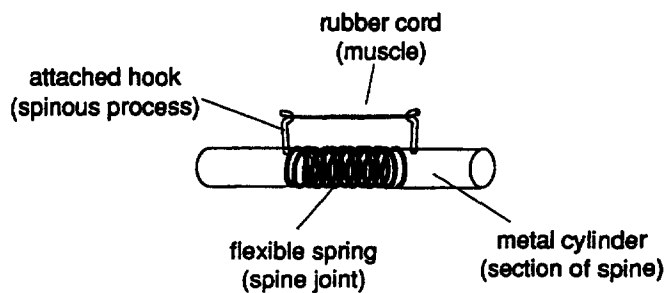

Fig. 5. Drawing of the mechanical cat mechanism.

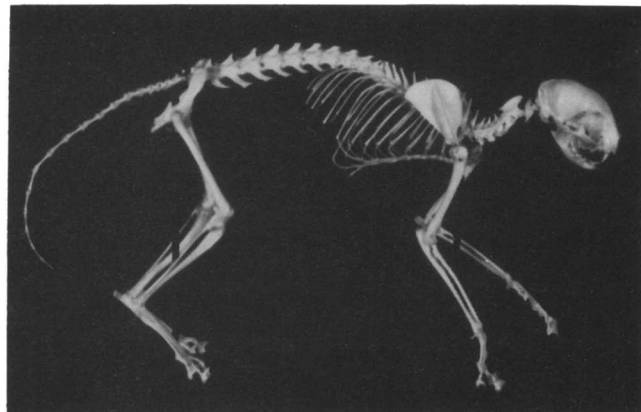

Fig. 6. Photograph of a cat skeleton.

gravity. Note again that the bent “spine” is crucial to this method of twisting.

Experiments

The sequence of photographs in Figs. 9 through 18 (see page 407) shows the larger model of the mechanical cat with legs as it is allowed to free fall from an inverted position. The sequential frames are spaced $1/30$ s apart. This shows that the mechanical cat flips over in about three frames, or about $1/10$ s, after falling about 2 in (~ 5 cm). Notice that *after the initial twist, the fall is rotation free*; this confirms that the net torque is zero and that the net angular momentum remains zero.

I also have photo sequences, again at $1/30$ -s intervals, of real cats falling and twisting, in each case landing on a soft surface. At no time was any cat observed to land other than on its feet, except when the torso was held rigid by a roll of cardboard that kept the spine from bending, but allowed for twist and countertwist. Under that constraint, the cat fell on its back (again on a very soft surface).

The inability of the cat to negotiate the twist without bending its spine gives further support to the idea that the primary mechanism is the same as that of the mechanical cats described here. However, close observation of these and other photographs^{4,6,8} of real cats shows that leg retraction and extension does take place to some extent. I conclude that changing the relative moments of inertia makes the process more efficient, but that it is only of secondary importance.

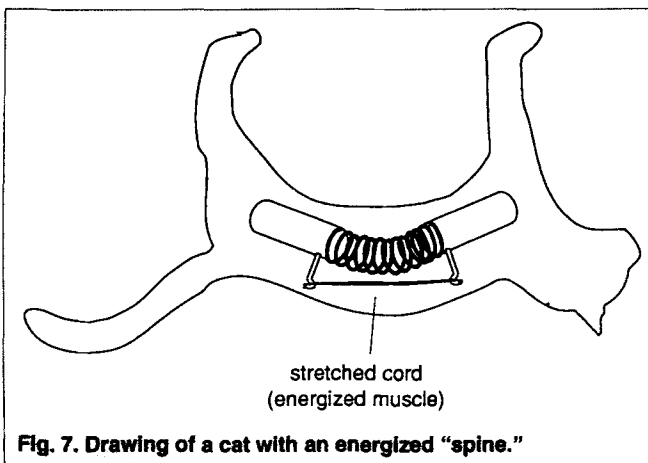

Fig. 7. Drawing of a cat with an energized "spine."

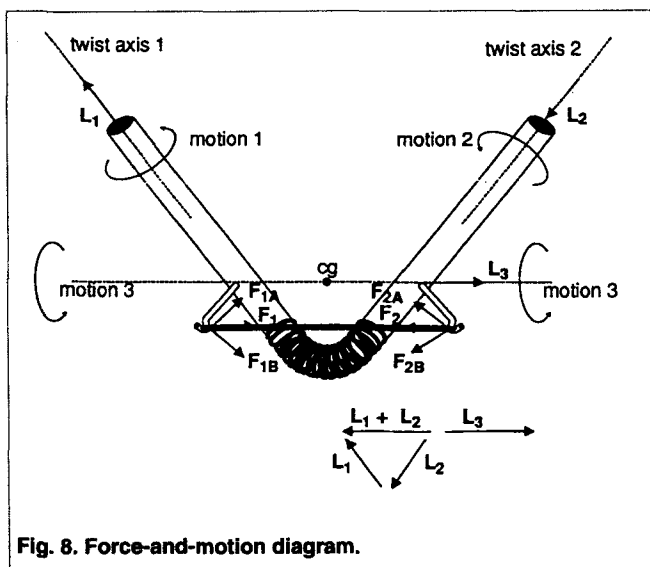

Fig. 8. Force-and-motion diagram.

Analysis

Figure 8 shows that the flipping-over motion consists of the two halves twisting toward one another (motions 1 and 2). Motion 3 simply involves the spine joint moving into the page and up and around the center of gravity. It does not play a major role in the orienting of the legs toward the ground. In fact, motion 3 is of relatively small magnitude, compared with motions 1 and 2, when the relative moments of inertia of the halves (I_1 and I_2) are small compared with that of the total system (I_3), and when the geometry is such that the torques from F_{1B} and F_{2B} do not dominate the torques from F_{1A} and F_{2A} . For the real cat, I_1 and I_2 can be made smaller, and thus the flip time can be made shorter by the cat retracting its legs or by extending them along the respective twist axes. Again, in my view, the changes in the relative moments of

inertia are secondary to the primary mechanism described in this analysis.

Discussion

Although the forces F_1 and F_2 in Fig. 8 cancel as an action-reaction pair, the separate components F_{1A} and F_{2A} , and also F_{1B} and F_{2B} do not cancel in pairs. This is what allows for the torques on each respective half to cause the twisting and rolling motion, resulting in the "cat" turning over. F_{1A} and F_{2A} produce the torques that cause motions 1 and 2, respectively, whereas F_{1B} and F_{2B} are responsible for motion 3.

From an energy standpoint, the twisting may be understood in terms of the cord becoming shorter as the "cat" twists. That is, the potential energy of the stretched cord or taut muscle is converted to kinetic energy of turning over, and subsequently converted to heat as the twisting stops. (Details of stopping the twist are not analyzed here.)

Other related questions may be asked: Can other animals and humans do the same type thing? Can tailless Manx cats do it? Are visual cues necessary? Answers are in the literature, and can be summarized briefly: Yes, to all three questions. Humans, with some effort, can do a quick torque-free twist from a springboard over water.¹⁰ Manx cats perform perfectly normally,² landing on their feet. Visual cues are very important and appear to be necessary for real cats.²

Conclusion

The mechanical cat can perform a torque-free twist very much like that of the real cat. Since this procedure is simpler than others proposed, it seems that the "smart" cats would make it the primary mechanism of choice. The rotation/counter-rotation mechanism has not been entirely ruled out, but it appears unlikely that any significant counter-rotation occurs.

References

1. Editor, *Nature* **51**, 80 (1894).
2. D. McDonald, *New Sci.* **7**, 1647 (1960).
3. C. Frohlich, *Am. J. Phys.* **47**, 583 (1979).
4. C. Frohlich, *Sci. Am.* **242** (3), 155 (1980).
5. K. Laws, *Am. J. Phys.* **56**, 81 (1988).
6. P. Hewitt, *Conceptual Physics*, 7th ed. (Harper Collins, New York, 1993), pp. 133–134.
7. J. Kane and M. Sternheim, *Physics*, 2nd ed. (Wiley, New York, 1983), pp. 156–157.
8. J. Wilson, *Physics—A Practical and Conceptual Approach*, 3rd ed. (Saunders, New York, 1993), p. 151.
9. J.E. Fredrickson, *Phys. Teach.* **27**, 620 (1989).
10. D. McDonald, *New Sci.* **10**, 501 (1961).

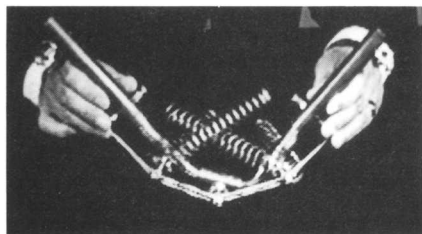

Fig. 9.

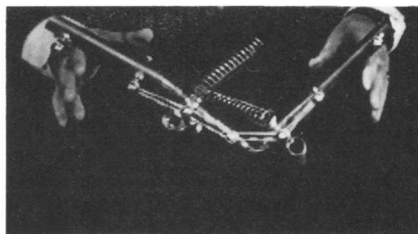

Fig. 10.

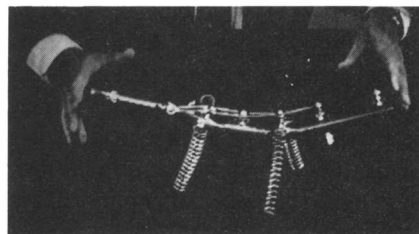

Fig. 11.

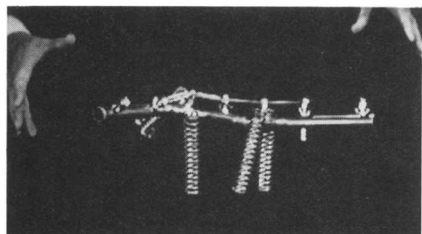

Fig. 12.

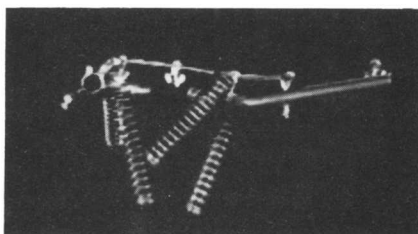

Fig. 13.

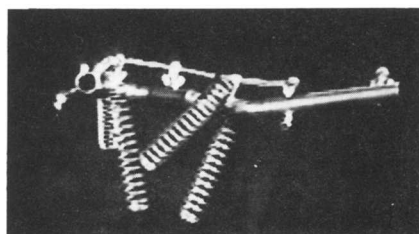

Fig. 14.

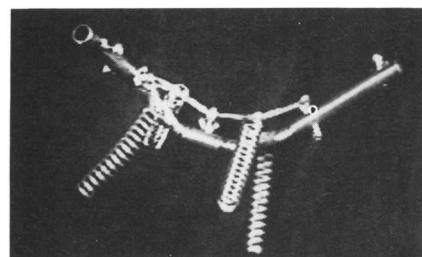

Fig. 15.

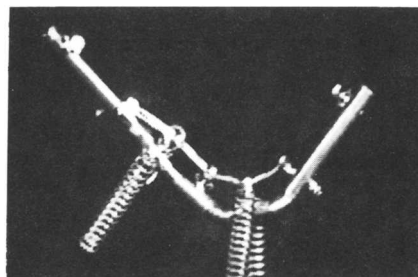

Fig. 16.

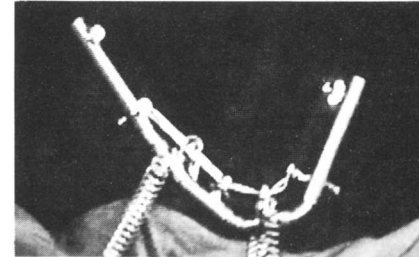

Fig. 17.

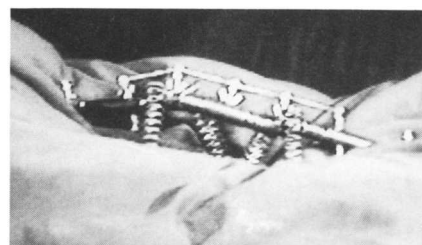

Fig. 18.

Figs. 9–18. Ten-frame sequence of the falling, twisting mechanical cat. Frames are spaced $1/30$ s apart.